



TSUGAMI
AMERICA

B0205-V

CNC PRECISION AUTOMATIC LATHE

- 20mm Capacity Swissturn
- 21 Tool Positions
- Chucker Convertible
- Increased Main and Back Spindle Power
- Fanuc Oi-TF Plus CNC Control

tsugamiamerica.com

B0205-V

5-AXIS VERTICAL GANG TOOL SWISS CNC LATHE

SPEED

- The B0205-V features a state of the art Fanuc control for low idle times and high speed cutting.
- Your B0205-V is our fastest 20mm machine! The main spindle can run 10,000 rpm and the back spindle can run 12,000 rpm.
- The horizontally opposed gang tool layout offers the shortest tool path and therefore, the quickest possible chip to chip time.
- Rounding out the features are integral servo spindle motors and servo driven bushing for fastest possible acc/dec times and quick C-axis positioning.

ACCURACY

- Tsugami has long been known for machine accuracy over time. The symmetrically designed castings, spindle cooling, A-frame design of the gang slide and thermal compensation on some models all work in concert to provides long term repeatable accuracy.

RIGIDITY

- The Tsugami B0205-V is built for the long haul. It features rugged construction, massive base and axis castings, belt free integral motor spindles, live tools, and integral motor drive bushing.
- Built on a heavy duty one piece cast iron base with thermally symmetrical construction, this machine features 0.1 micron axis resolution. A more rigid platform allows higher speeds and feeds.
- For extra peace of mind, the machines, motors, and Fanuc controls are covered by an industry leading two-year parts and service warranty.



B0205-V Tool Zone

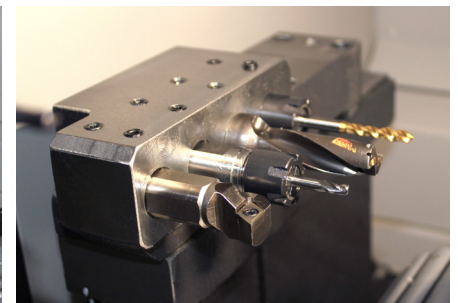

B0205-V Backworking Block

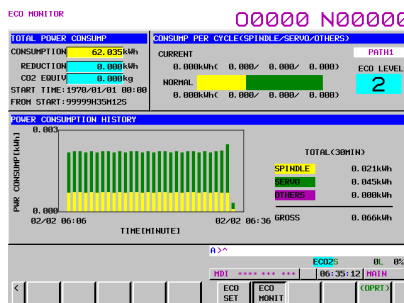

Tsugami ECO Mode

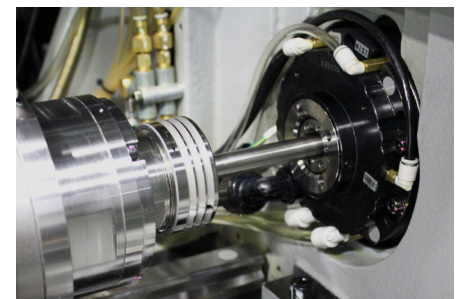

Servo Driven Guide Bushing

WORK ZONES & MODULAR TOOLING

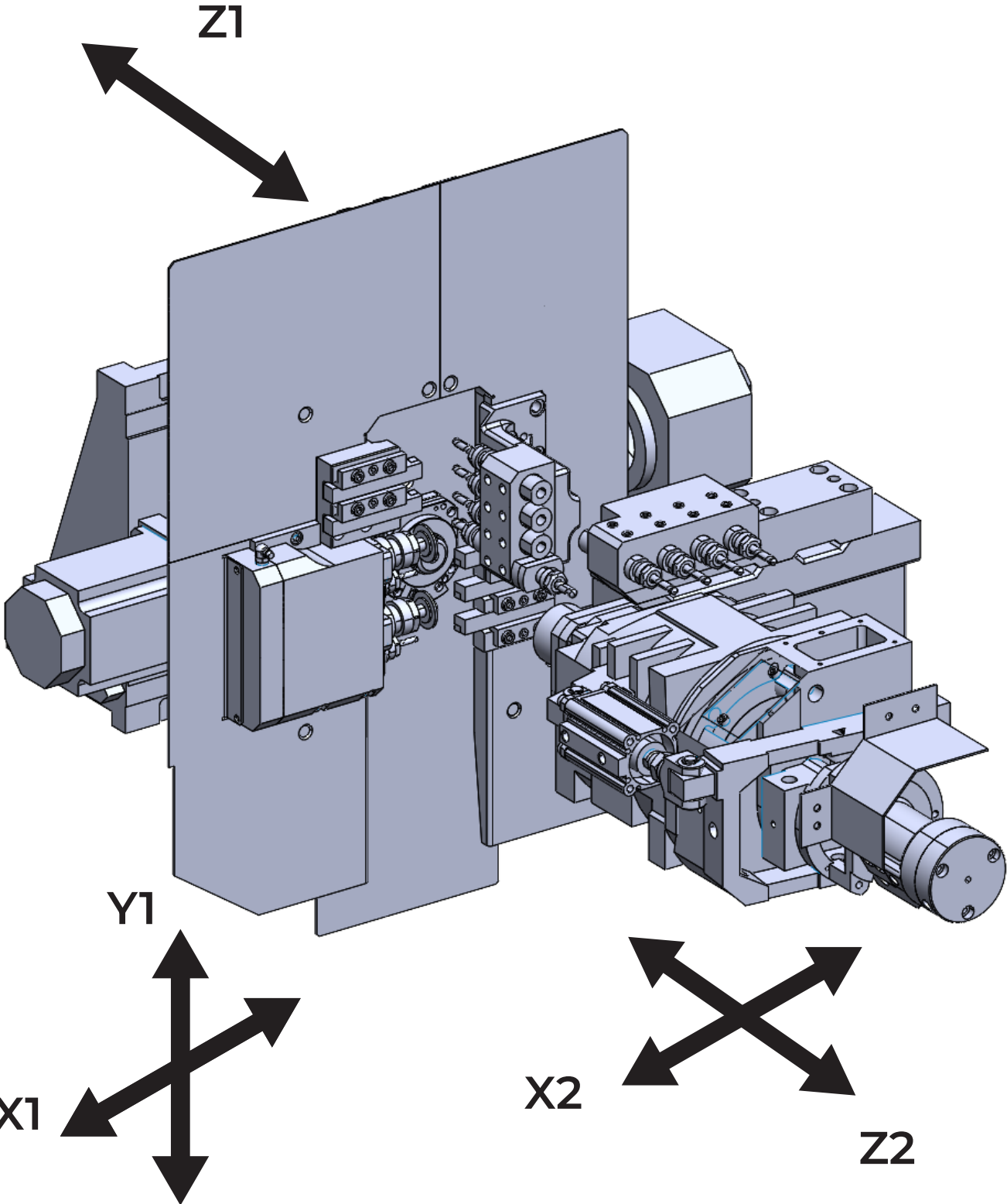

CHUCKER CONVERTIBLE

The B0205-V can be changed over in minutes. Adding a Chucker Kit allows you to convert your B0205-V from a traditional sliding headstock Swiss function to standard lathe-type chucker mode. This allows you to run high precision parts utilizing standard drawn barstock. Other benefits include shorter remnant, better concentricity and more. This quick-change flexibility makes these machines ready to tackle whatever job comes in the door.

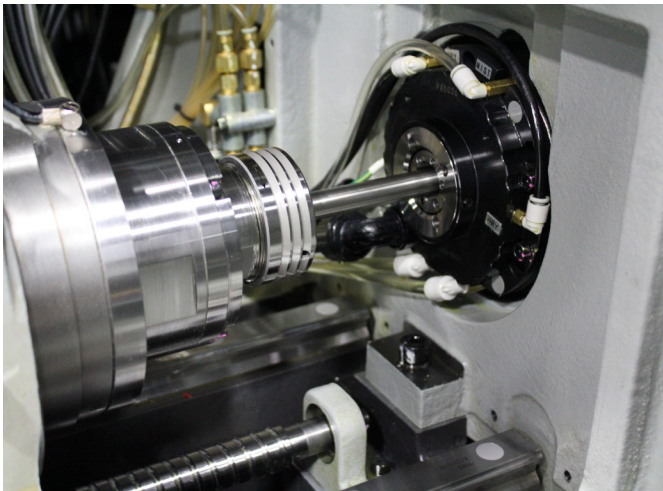

Running in Swiss Mode

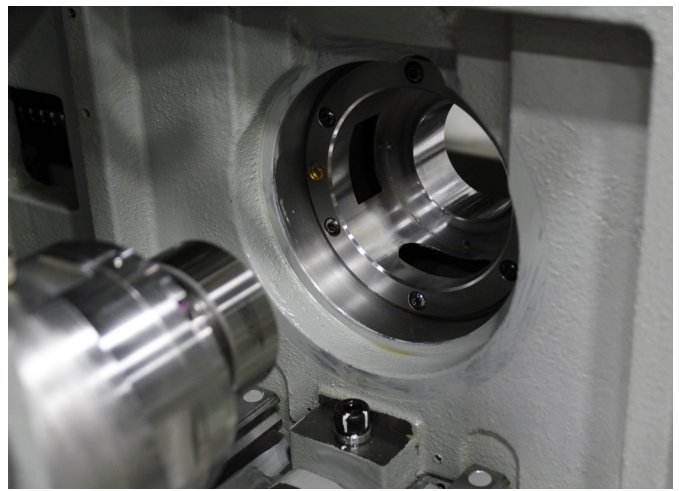

Running in Chucker Mode

NEED CUSTOM ACCESSORIES?

From the machine Make Ready process, to integrating mechanical and robotic loading and unloading systems, to custom tool creation and spindle repair, IMG is dedicated to supporting all Tsumagi users in North America!



Grinding Room



Make Ready Facility



Milling Room

OSCILLATION CUTTING

Oscillation Cutting is a technological breakthrough that oscillates a servo axis to help break chips in tough to cut materials, reduces heat in the cut, while not diminishing tool life.

- Productivity is increased by significantly reducing operator interruption to remove hanging or bird nesting chips.
- Easy to program by special G code
- Oscillation parameters can be changed easily within the program for machining multiple features with multiple tools.
- Can be used for many machining operations including OD turning, drilling, boring, grooving, cutoff, circular interpolation, and most FANUC canned cycles.

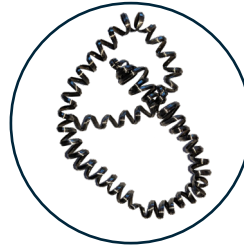

**WITHOUT
OSCILLATION**

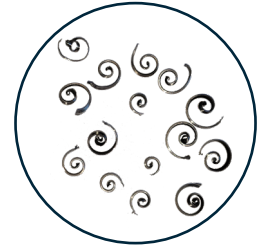

**WITH
OSCILLATION**

ABILE SOFTWARE

- Developed by Tsugami, Abile is capable of programming moderately complex machined parts. Abile incorporates all basic machines featured and several material types with predetermined feed rates.
- Abile allows first time users to quickly become proficient with Swiss processing despite having limited knowledge. Abile comes free with your machine purchase and requires no license fees, maintenance agreements, or seat limitations.
- Abile allows you to generate a 2 or 3-path part program, complete, with specific and editable codes in standard FANUC G Code format. Abile automatically generates machine process and provides component run times.

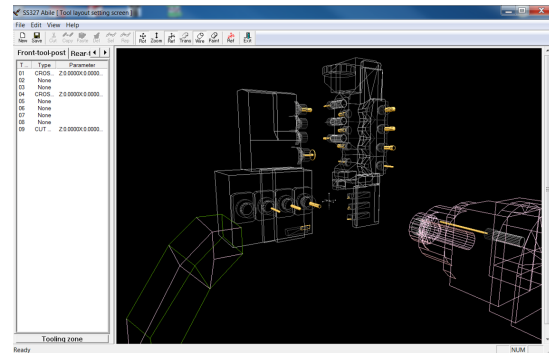

Program Generator

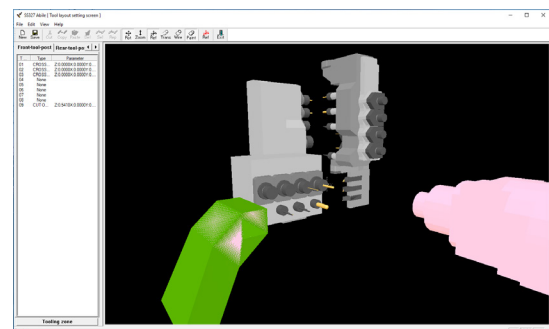

Tool Setting

MACHINE STANDARD SPECIFICATIONS

	ITEMS	B0205-V
MACHINING RANGE	Max. Chucking Barstock Diameter	Ø3 mm to Ø20 mm (.12 in. to .78 in.)
	Max. Machining Length	170 mm (6.79 in.) (Direct-drive rotary guide bushing) 45 mm (1.87 in.) (Guide-bushless) 210 mm (8.27 in.) (Stationary guide bushing) 80 mm (3.15 in.) (Carrier type rotary guide bushing)
	Max. Drilling Diameter	Ø10 mm (.39 in.)
	Max. Tapping Diameter	M10
	Max. Back Spindle Chucking Barstock Diameter	Ø20 mm (.78 in.)
	Max. Back Spindle Drilling Diameter	Ø10 mm (.39 in.)
	Max. Back Spindle Tapping Diameter	M10
	Max. Tool Spindle Drilling Diameter	Ø6 mm (.24 in.) (Front tool post/Back tool post)
	Max. Tool Spindle Tapping Diameter	M5 (Front tool post */Back tool post)
MACHINING CAPABILITY	Max. Tool Spindle Slotting Cutter Diameter	Ø30 mm (1.2 in.) (Front tool post)
	Main Spindle Speed	Max. 10,000 min ⁻¹ (Rated speed: 8,000 min ⁻¹)
	Back Spindle Speed	Max. 12,000 min ⁻¹ (Rated speed: 8,000 min ⁻¹)
	Rotary Guide Bushing Speed	Carrier type: Max. 8,000 min ⁻¹ (Rated speed: 6,000 min ⁻¹) Direct-drive type: Max. 12,000 min ⁻¹ (Rated speed: 8,000 min ⁻¹)
	Live Tool Speed	Front tool post: Max.10,000 min ⁻¹ (Rated speed: 6,800 min ⁻¹) Back tool post: Max.8,000 min ⁻¹ (Rated speed: 6,400 min ⁻¹)
	Tool Storage Capacity (Standard)	21
	Tool Size	.5 x .5"
	Rapid Traverse Rate	36m/min (X2, Z2), 32m/min (Y1,Z1), 24m/min (X1)
MOTORS	Main Spindle	4.9/7.3 Hp (3.7/5.5 kW)
	Back Spindle	2.9/4.9Hp (2.2/3.7 kW)
	Linear Axes	0.5 kW (Z1: 0.75 kW)
	Live Tool	1.0 kW (Front tool post) 0.75 kW (Back tool post-Option)
	Coolant Pump	0.3Hp (0.25 kW)
	Lubricating Pump	3 W
	Compressed air requirement	0.4 MPa or above
	Air discharge rate	100 NL/min
OTHER	Power Source Requirements	12.9 kVA
	Coolant Tank Capacity	180 L
	Width x depth x height	1,750 x 1,055 x 1,700 mm 68.9" x 41.5" x 66.9"
	Weight	1,800 kg (3,968 lbs.)

NC SPECIFICATIONS

ITEMS

B0205-V

NC Unit	FANUC Oi-TF Plus
Controlled Axis	X1, Z1, Y1, X2, Z2
Least Input Increment	0.0001 mm (X-axis in diameter)
Maximum Programmable Value	±8 digits
Interpolation Method	Linear/circular
Feedrate Function	1 - 6,000 mm/min
Feedrate Override	0 to 150%, 10% step
Dwell	G04, 0 to 99999.999
ABS/INC Command	X, Z, Y: Absolute U, W, V: Incremental
Number of Tool Offset	Main: 64 Back: 64
LCD/MDI	10.4" color LCD
Display Language	English
Part Program Storage	2 Mbyte (sum of main and back)
Registerable Programs	1,000 (sum of main and back)
Miscellaneous Functions	Main: M5-digits Back: M3-digits
Spindle Function	S Code 5 digits
Tool Function	T Code 4 digits

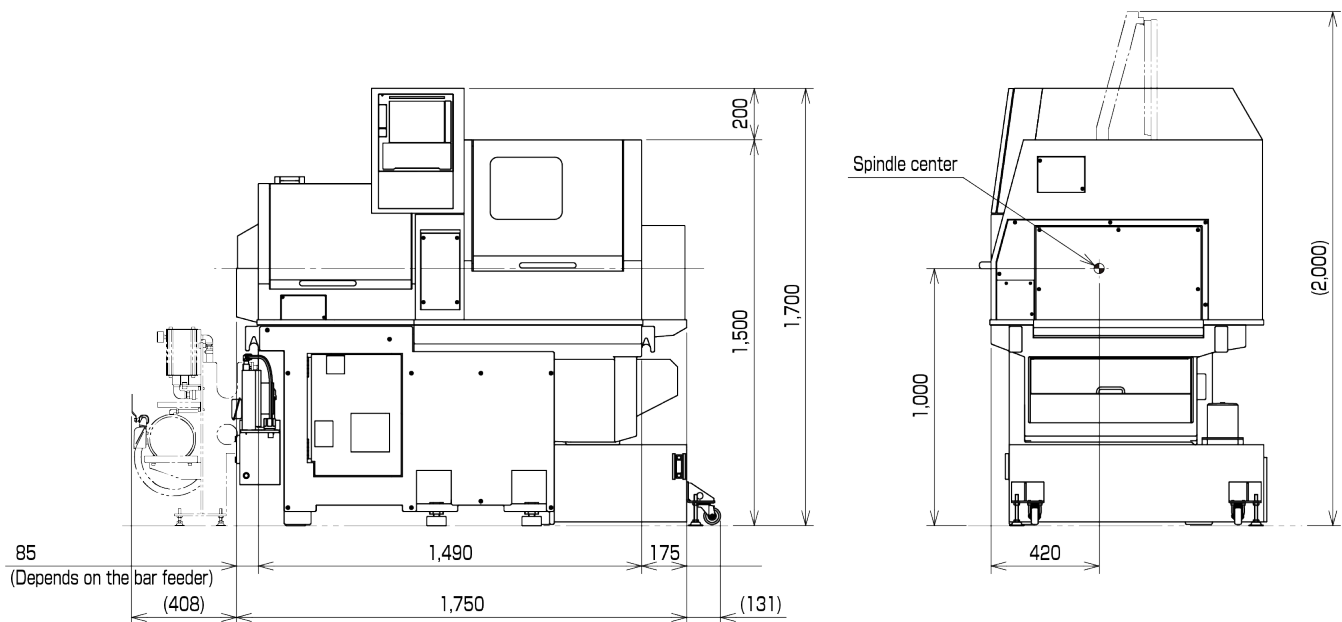

Since 1978, Tsugami America (formerly known as Tsugami/Rem Sales) has been the exclusive source for Precision Tsugami CNC machine tools in North America. Headquartered in Windsor, CT, Tsugami America provides machine tools and engineering expertise through an extensive network of authorized distributors and technical centers. Technical support and customer service are available throughout North America. Our distributors' trained service personnel provide technical support throughout the long life-cycle of our Tsugami machine tools, and work hand-in-hand with Tsugami America's engineers to deliver common-sense solutions to everyday problems.

Our application engineers help customers tackle and solve the toughest high-precision manufacturing challenges, on-time and on-budget. We have a 35-year history and reputation of serving the needs of small parts manufacturers in North America with the highest level of expertise and customer care. Our industry-respected, knowledgeable staff is comprised of both long-time employees and fresh faces all who share a commitment to provide you, our customers, with the competitive advantage to "do more with less" every day.

DISTRIBUTION NETWORK

The Robert E. Morris Company

Serving: CT, MA, RI, NH, VT, ME, NY, NJ
www.robertemorris.com

Morris South

Serving: NC, SC, GA, VA, AL, MS, TN, AR, FL
www.morrisouth.com

Morris Great Lakes

Serving: NY, PA, WV
www.morrisgreatlakes.com

Morris Midwest Minnesota

Serving: MN, ND, SD
www.morrismidwest.com

Morris Midwest Wisconsin & Illinois

Serving: WI, IL, MI Upper Peninsula
www.morrismidwest.com

Cnczilla Co.

Serving: PA, NJ, DE, MD
www.cnczilla.com

Technical Equipment Sales Co

Serving: OH, IN, KY
www.techequip.com

Ellison Technologies

Serving: CA, WA, OR, NV
www.ellisontechnologies.com

Hartwig, Inc.

Serving: MO, IL, IA, KS, CO, OK, TX, LA, MT, UT, NM, ID, WY
www.hartwiginc.com

Protecnic de México, S.A de C.V.

Serving: Mexico
www.protecnic.com.mx

Arizona CNC

Serving: AZ, NV
www.arizonacnc.com

EMEC Machine Tools Inc.

Serving: Eastern Canada
www.emecmt.com

Trident Machine Tools Southeast

Serving: FL
www.trident-se.com

Methods & Equipment Associates

Serving: MI
www.methods-equipment.com

Thomas Skinner

Serving: Western Canada
www.thomasskinner.com

TSUGAMI AMERICA LOCATIONS

ELGIN, IL

Technical Center

2400 Vantage Dr.
Elgin, IL 60124

WINDSOR, CT

Corporate Headquarters

910 Day Hill Road
Windsor, CT 06095

FULLERTON, CA

Technical Center

1521 E Orangethorpe Ave, Suite E
Fullerton, CA 92831

860-687-3400 Phone | 860-687-3401 Fax | www.tsugamiamerica.com | sales@tsugamiamerica.com

TSUGAMI AMERICA IS ISO 9001:2015 CERTIFIED QMS